

# GESTO



GESTO TAMBUK MOTOR  
GESTO DRUM MOTORS

	G 80	G 100	G 113	G 125	G 138	G 165	G 216	G 315	G 400	G 500	G 630
<b>DIŞ PARÇALAR (EXTERNAL PARTS)</b>											
<b>DIŞ TAMBUR BORU (DRUM SHELL)</b>											
MALZEME MATERIAL	Standart Çelik (Mild Steel)	S	S	S	S	S	S	S	S	S	S
	Paslanmaz Çelik (Stainless Steel)	0	0	0	0	0	0	0	0	X	X
SEKİL SHAPE	Konik Açılı İşlenmiş (Crowned Shell)	S	S	S	S	S	S	S	S	S	S
	Silindirik Düz İşlenmiş (Cylindrical Shell)	0	0	0	0	0	0	0	0	0	0
	Özel Yivler Açılmış (With Special Grooves)	0	0	0	0	0	0	0	0	0	0
KAPLAMA LAGGING	Çark Dişli Monteli (With Sprocket)	0	0	0	0	0	0	0	0	0	0
	Sıcak Vulkanize Kaplama (Hot Vulcanized Lagging)	S	S	S	S	S	S	S	S	S	S
	Soğuk Kaplama (Cold Lagging)	0	0	0	0	0	0	0	0	0	0
	FDA Onaylı Kaplama (FDA Approved)	0	0	0	0	0	0	0	0	0	0
<b>YAN KAPAKLAR (END FLANGES)</b>											
MALZEME MATERIAL	Aluminyum (Aluminium)	S	S	S	0	0	0	X	X	X	X
	Dökme Demir (Cast Iron)	X	X	X	S	S	S	S	S	X	X
	Standart Çelik (Mild Steel)	0	0	0	0	0	0	0	0	S	S
	Paslanmaz Çelik (Stainless Steel)	0	0	0	0	0	0	0	0	0	0
SEKİL SHAPE	Standart Yivsiz (Standard Without Grooves)	S	S	S	S	S	S	S	S	S	S
	(V) veya (O) Yiv Açılmış (With V / O Groove)	0	0	0	0	0	0	0	0	0	0
	Çark Dişli Monteli (With Sprocket)	0	0	0	0	0	0	0	0	0	0
<b>MİLLER VE CIVATALAR (SHAFTS AND SCREWS)</b>											
MALZEME MATERIAL	Standart Çelik (Mild Steel)	S	S	S	S	S	S	S	S	S	S
	Paslanmaz Çelik (Stainless Steel)	0	0	0	0	0	0	0	0	0	0
SEKİL SHAPE	4 Kenar Küttü (Square Type) <input checked="" type="checkbox"/>	0	0	0	S	S	S	S	S	S	S
	2 Kenar Küttü (Two Side Flat) <input checked="" type="checkbox"/>	S	S	S	0	0	0	0	0	X	X
	Karşılıklı Komple Metrik Diş Açılmış (Cross Drilled Thread)	S (M6)	S (M8)	S (M8)	0 (M8)	0 (M8)	0 (M10)	0 (M10)	X	X	X
<b>ELEKTRİK BAĞLANTISI (ELECTRICAL CONNECTION)</b>											
	Klemens Kutulu (Terminal Box)	0	0	0	S	S	S	S	S	S	S
	Milde Sök-Tak Soketli (With Plug Solution)	S	S	S	0	0	0	X	X	X	X
	Düz Rakorlu (Straight Connector)	0	0	0	0	0	0	0	0	0	0
	Dirsek Rakorlu (Elbow Connector)	0	0	0	0	0	0	0	0	0	0

S Standart Standard    0 Opsiyonel Optional    X Yok None

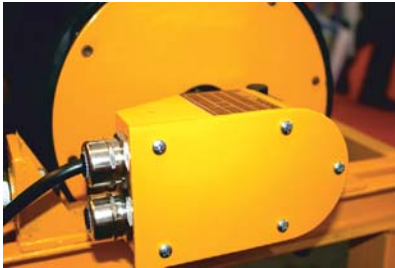

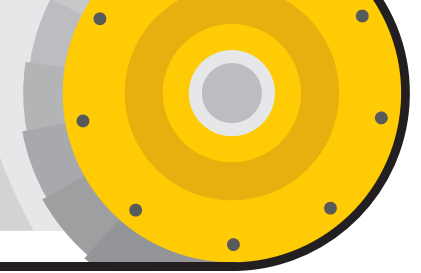

	G 80	G 100	G 113	G 125	G 138	G 165	G 216	G 315	G 400	G 500	G 630
<b>İÇ PARÇALAR (INTERNAL PARTS)</b>											
<b>ELEKTRİK MOTORU (ELECTRICAL MOTOR)</b>											
Asenkron Sincap Kafes (Asynchronous Squirrel Cage)	S	S	S	S	S	S	S	S	S	S	S
<b>Motor Yalıtım Sınıfı (Motor Isolation Class)</b>											
H	0	0	0	0	0	0	0	0	0	0	0
F	0	0	0	S	S	S	S	S	S	S	S
B	S	S	S	0	0	0	X	X	X	X	X
<b>Voltaj (Voltage)</b>											
3 x 230/400 V 50/60 Hz	X	S	S	S	S	S	S	S	S	S	X
3 x 400/690 V 50/60 Hz	X	S	S	S	S	S	S	S	S	S	S
1 x 230 V 50 Hz	S	S	S	0	0	0	X	X	X	X	X
1 x 115 V 60 Hz	0	0	0	0	0	0	X	X	X	X	X
Diğer Voltajlar (Other Voltages)	0	0	0	0	0	0	0	0	0	0	0
Dual Voltaj (Dual Voltages)	X	X	S	S	S	S	S	S	S	S	S
Tek Değerli Voltaj (Single Rated Voltage)	S	S	0	0	0	0	0	0	0	0	0
Termal Koruma (Thermal Protection)	0	0	0	0	0	0	0	0	0	0	0
Frekans Konvertörü Uyumu (Frequency Inverter Compatibility)	S	S	S	S	S	S	S	S	S	S	S
<b>Koruma Sınıfı (IP Protection)</b>											
IP 66	0	0	0	S	S	S	S	S	S	S	S
IP 64	S	S	S	X	X	X	X	X	X	X	X
<b>İÇ VE DIŞ SIZDIRMAZLIK (EXTERNAL AND INTERNAL SEAL)</b>											
İÇ (INT.)	Çift Dudaklı Tandem FPM+NBR (Double Lipped Tandem FPM+NBR)	0	0	0	0	S	S	S	S	S	S
	Çift Dudaklı Tekli FPM (Double Lipped FPM)	S	S	S	S	0	0	0	0	0	0
DIŞ (EXT.)	Standart Toz Keçe (Standard Wiper Seal)	S	S	S	S	S	S	S	S	S	S
	Yüksek Su Basıncı Dayanımlı (High Pressure Washdown Applications)	0	0	0	0	0	0	0	0	0	0
	Labirent Keçe (Labyrinth Seal)	0	0	0	0	0	0	0	0	0	0
<b>DIŞLİ GRUBU (GEARS)</b>											
Yüksek Dayanımlı Polimer Dişli (Polymer Gears)	S	S	S	0	0	0	X	X	X	X	X
Isıl İşlemle Sertleştirilmiş Çelik Dişli (Hardened Steel)	S	S	S	S	S	S	S	S	S	S	S
<b>DIĞER OPSİYONLAR VE SERTİFİKALAR (OTHER OPTIONS AND CERTIFICATES)</b>											
Mekanik Geri Dönüş Freni (Mechanical Back Stop)	0	0	0	0	0	0	0	0	0	0	0
Elektromanyetik Fren (Electro Magnetic Brake)	0	0	0	0	0	0	0	0	0	0	0
Enkoder (Encoder)	0	0	0	0	0	0	0	0	0	0	0
Çift Hızlı Motor Dahlander (Two Speed Motor Dahlander)	X	X	X	X	0	0	0	0	0	0	0
Uzun Ömürlü Sentetik Yağ (Synthetic Oil)	0	0	0	0	0	0	0	0	0	0	0
Düşük Sıcaklık Uygulamalarına Özel Yağ (Low Temperature App. Oil)	0	0	0	0	0	0	0	0	0	0	0
Gıda Uygulamaları için FDA Onaylı Yağ (FDA Approved Oil)	0	0	0	0	0	0	0	0	0	0	0
Standart Dışı Boru Uzunlukları (Non Standard Shell Length)	0	0	0	0	0	0	0	0	0	0	0
Standart Dışı Mil Tasarımları (Non Standard Shaft Design)	0	0	0	0	0	0	0	0	0	0	0
CE Sertifikası (CE Certificate)	S	S	S	S	S	S	S	S	S	S	S
UL /CSA /ATEX 95 ZONE 22	0	0	0	0	0	0	0	0	0	0	0

### G80 & G100 & G113

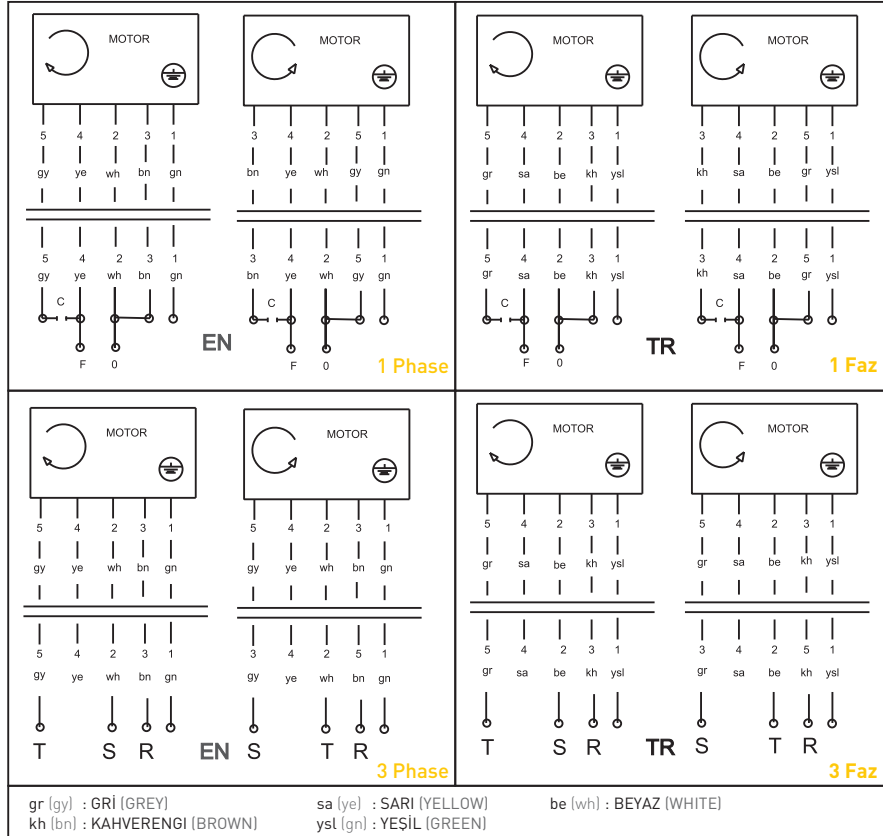

### G500 & G630 Kompakt | Compact

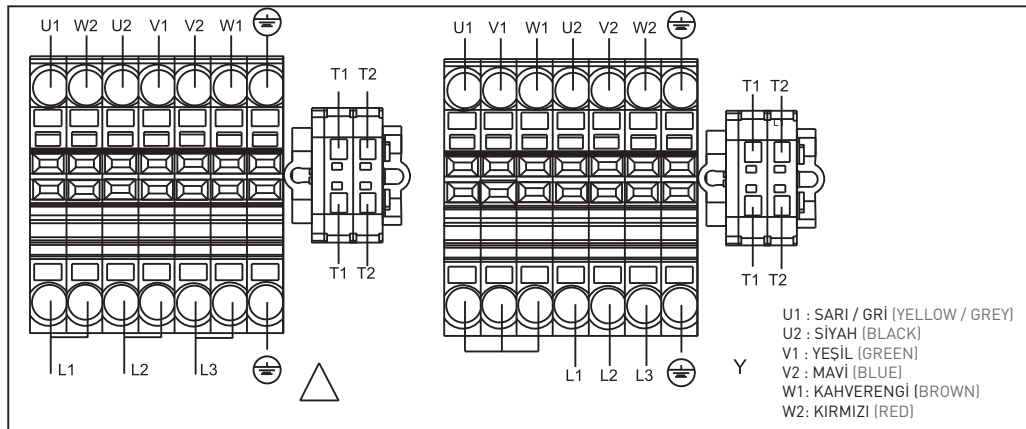

### G127 & G138 & G165 & G216 Kompakt | Compact

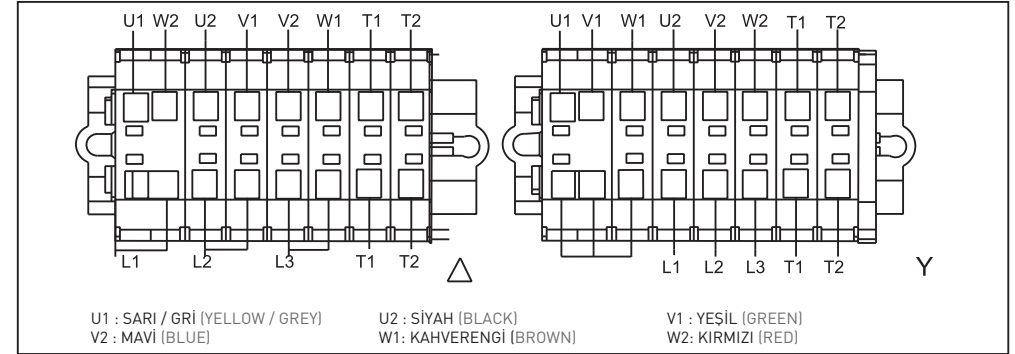

### G216 & G315 & G400 & G500 & G630 Kompakt | Compact ≤ 4 Kw

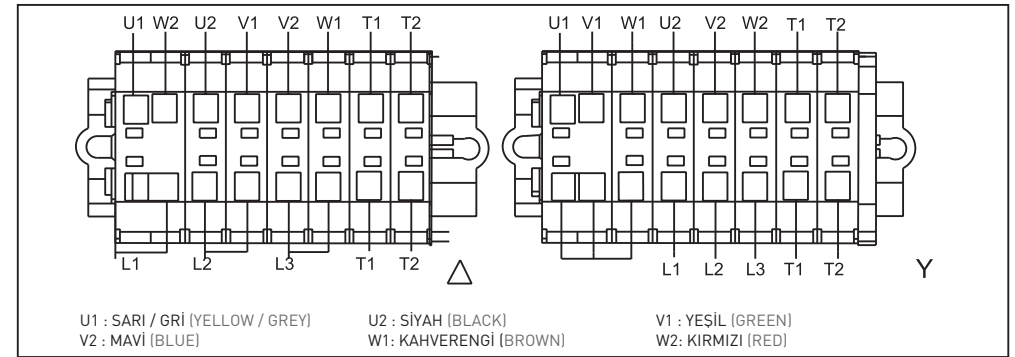

### G216 & G315 & G400 & G500 & G630 Standart | Standard > 4 Kw

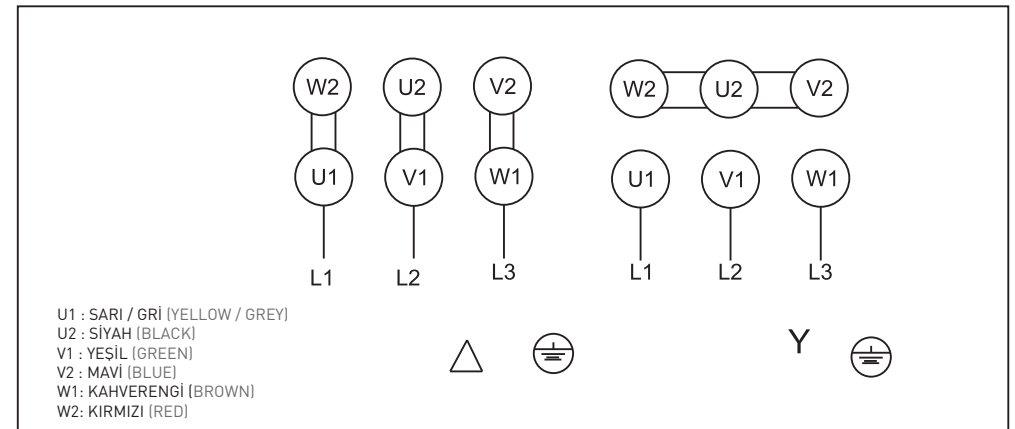

# GESTO

[www.gesto.com.tr](http://www.gesto.com.tr)

A | 1474. Sk. No: 13 İvedik / Ankara / TURKIYE

T | +90 312 354 37 86

@ | [info@gesto.com.tr](mailto:info@gesto.com.tr)



[www.gesto.com.tr](http://www.gesto.com.tr)

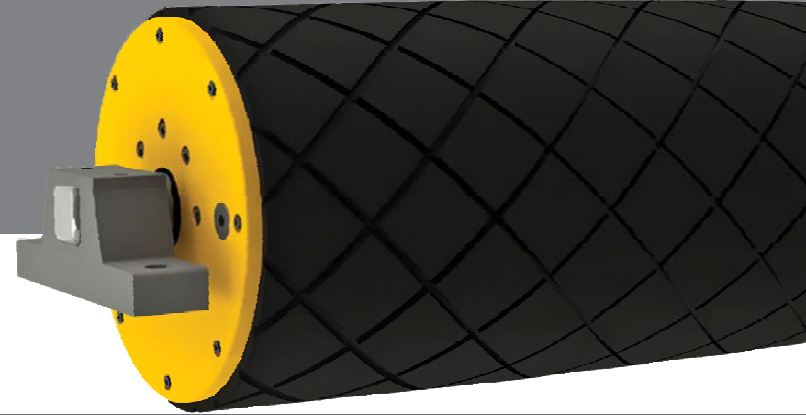

GESTO TAMIRIYER MOTOR  
GESTO DRUM MOTORS